

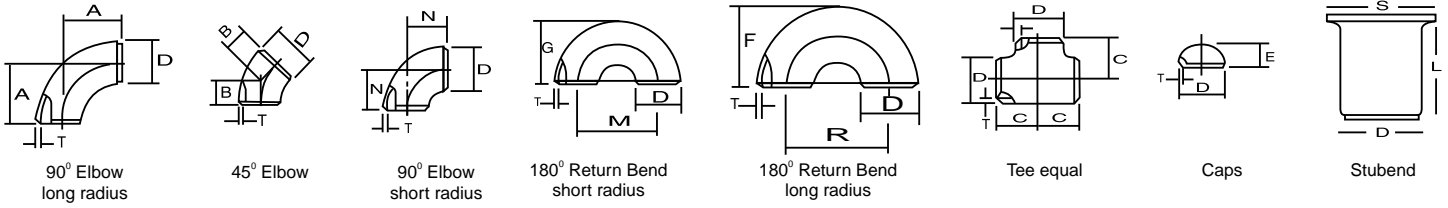



BUTT WELDING PIPE FITTING DIMENSIONAL STANDARD

ANSI B-16.9 / 16.28 / MSS SP-43



Nominal Pipe Size		Outside Diameter	Center to Face				Back to Face			Center to Center			Length 'L'	
Inch.	mm	D	A	B	C	N	E	F	G	R	M	S	MSS SP43	ANSI B 16.9
1/2	15	21.3	38	16	25	—	25	48	—	76	—	34.9	50.8	76.2
3/4	20	26.7	29	11	29	—	25	43	—	57	—	42.8	50.8	76.2
1	25	33.4	38	22	38	25	38	56	41	76	51	50.8	50.8	101.6
1 1/4	32	42.2	48	25	48	32	38	70	52	95	64	63.5	50.8	101.6
1 1/2	40	48.3	57	29	57	38	38	83	62	114	76	73.0	50.8	101.6
2	50	60.3	76	35	64	51	38	106	81	152	102	92.0	63.5	152.4
2 1/2	65	73.0	95	44	76	64	38	132	100	191	127	104.8	63.5	152.4
3	80	88.9	114	51	86	76	51	159	121	229	152	127.0	63.5	152.4
3 1/2	90	101.6	133	57	95	89	64	184	140	267	178	139.7	76.2	152.4
4	100	114.3	152	64	105	102	64	210	159	305	203	157.2	76.2	152.4
5	125	141.3	190	79	124	127	76	262	197	381	254	185.7	76.2	203.2
6	150	168.3	229	95	143	152	89	313	237	457	305	215.9	88.9	203.2
8	200	219.1	305	127	178	203	102	414	313	610	406	270.0	101.6	203.2
10	250	273.1	381	159	216	254	127	518	391	762	508	324.0	127.0	254.0
12	300	323.9	457	190	254	305	152	619	467	914	610	381.0	152.4	254.0
14	350	355.6	533	222	279	356	165	711	533	1067	711	412.8	152.4	305.0
16	400	406.4	610	254	305	406	178	813	610	1219	813	470.0	152.4	305.0
18	450	457.2	686	286	343	457	203	914	686	1372	914	533.4	152.4	305.0
20	500	508.0	762	318	381	508	229	1016	762	1524	1016	584.2	152.4	305.0
22	550	559.0	838	343	419	559	254	1118	838	1676	1118	614.4	152.4	305.0
24	600	610.0	914	381	432	610	267	1219	914	1829	1219	692.2	152.4	305.0
26	650	660.0	991	406	495	660	267	—	—	—	—	—	—	—
28	700	711.0	1067	438	521	711	267	—	—	—	—	—	—	—
30	750	762.0	1143	470	559	762	267	—	—	—	—	—	—	—
32	800	813.0	1219	502	597	813	267	—	—	—	—	—	—	—
34	850	864.0	1295	533	635	864	267	—	—	—	—	—	—	—
36	900	914.0	1372	565	673	914	267	—	—	—	—	—	—	—
38	950	965.0	1448	600	711	965	305	—	—	—	—	—	—	—
40	1000	1016.0	1524	632	749	1016	305	—	—	—	—	—	—	—
42	1050	1067.0	1600	660	762	1067	305	—	—	—	—	—	—	—
44	1100	1118.0	1676	695	813	1118	343	—	—	—	—	—	—	—
46	1150	1168.0	1753	727	851	1168	343	—	—	—	—	—	—	—
48	1200	1219.0	1829	759	889	1219	343	—	—	—	—	—	—	—

BUTT - WELDING PIPE FITTINGS ANSI B 16.9 / 16.28

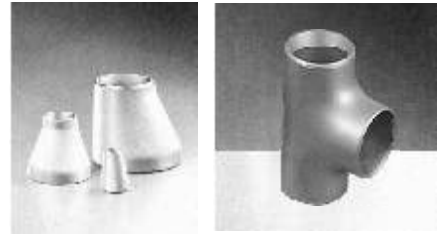
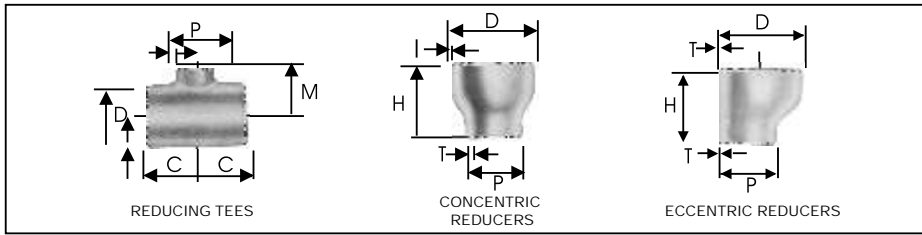

Nominal Pipe Size		Outside Diameter		Center to End		Length
Inch.	mm	D	P	C	M	H
1/2 x 3/8	15 x 10	21.3	17.1	25	25	-
1/2 x 1/4	15 x 8	21.3	13.7	25	25	-
3/4 x 1/2	20 x 15	26.7	21.3	29	29	38
3/4 x 3/8	20 x 10	26.7	17.1	29	29	38
1 x 3/4	25 x 20	33.4	26.7	38	38	51
1 x 1/2	25 x 15	33.4	21.3	38	38	51
1 1/4 x 1	32 x 25	42.2	33.4	48	48	51
1 1/4 x 3/4	32 x 20	42.2	26.7	48	48	51
1 1/4 x 1/2	32 x 15	42.2	21.3	48	48	51
1 1/2 x 1 1/2	40 x 32	48.3	42.2	57	57	64
1 1/2 x 1	40 x 25	48.3	33.4	57	57	64
1 1/2 x 3/4	40 x 20	48.3	26.7	57	57	64
1 1/2 x 1/2	40 x 15	48.3	21.3	57	57	64
2 x 1 1/2	50 x 40	60.3	48.2	64	60	76
2 x 1 1/4	50 x 32	60.3	42.2	64	57	76
2 x 1	50 x 25	60.3	33.4	64	51	76
2 x 3/4	50 x 20	60.3	26.7	64	44	76
2 1/2 x 2	65 x 50	73.0	60.3	76	70	89
2 1/2 x 1 1/2	65 x 40	73.0	48.3	76	67	89
2 1/2 x 1 1/4	65 x 32	73.0	42.2	76	64	89
2 1/2 x 1	65 x 25	73.0	33.4	76	57	89
3 x 2 1/2	80 x 65	88.9	73.0	86	83	89
3 x 2	80 x 50	88.9	60.3	86	76	89
3 x 1 1/2	80 x 40	88.9	48.3	86	73	89
3 x 1 1/4	80 x 32	88.9	42.2	86	70	89
3 1/2 x 3	90 x 80	101.6	88.9	95	92	102
3 1/2 x 2 1/2	90 x 65	101.6	73.0	95	89	102
3 1/2 x 2	90 x 50	101.6	60.3	95	83	102
3 1/2 x 1 1/2	90 x 40	101.6	48.3	95	79	102
3 1/2 x 1 1/4	90 x 32	101.6	42.2	-	-	102
4 x 3 1/2	100 x 90	114.3	101.6	105	102	102
4 x 3	100 x 80	114.3	88.9	105	98	102
4 x 2 1/2	100 x 65	114.3	73.0	105	95	102
4 x 2	100 x 50	114.3	60.3	105	89	102
4 x 1 1/2	100 x 40	114.3	48.3	105	86	102
5 x 4	125 x 100	141.3	114.3	124	117	127
5 x 3 1/2	125 x 90	141.3	101.6	124	114	127
5 x 3	125 x 80	141.3	88.9	124	111	127
5 x 2 1/2	125 x 65	141.3	73.0	124	108	127
5 x 2	125 x 50	141.3	60.3	124	105	127
6 x 5	150 x 125	168.3	141.3	143	137	140
6 x 4	150 x 100	168.3	114.3	143	130	140
6 x 3 1/2	150 x 90	168.3	101.6	143	127	140
6 x 3	150 x 80	168.3	88.9	143	124	140
6 x 2 1/2	150 x 65	168.3	73.0	143	121	140

Nominal Pipe Size		Outside Diameter		Center to End		Length
Inch.	mm	D	P	C	M	H
8 x 6	200x150	219.1	168.3	178	168	152
8 x 5	200x125	219.1	141.3	178	162	152
8 x 4	200x100	219.1	114.3	178	156	152
8 x 3 1/2	200x90	219.1	101.6	178	152	152
10 x 8	250x200	273.1	219.1	216	203	178
10 x 6	250x150	273.1	168.1	216	194	178
10 x 5	250x125	273.1	141.3	216	191	178
10 x 4	250x100	273.1	114.3	216	184	178
12 x 10	300x250	323.9	273.1	254	241	203
12 x 8	300x200	323.9	219.1	254	229	203
12 x 6	300x150	323.9	168.3	254	219	203
12 x 5	300x125	323.9	141.3	254	216	203
14 x 12	350x300	355.6	323.9	279	270	330
14 x 10	350x250	355.6	273.1	279	257	330
14 x 8	350x200	355.6	219.1	279	248	330
14 x 6	350x150	355.6	168.3	279	238	330
16 x 14	400x350	406.4	355.6	305	305	356
16 x 12	400x300	406.4	323.9	305	295	356
16 x 10	400x250	406.4	273.1	305	283	356
16 x 8	400x200	406.4	219.1	305	273	356
16 x 6	400x150	406.4	168.3	305	264	356
18 x 16	450x400	457.0	406.4	343	330	381
18 x 14	450x350	457.0	355.6	343	330	381
18 x 12	450x300	457.0	323.9	343	321	381
18 x 10	450x250	457.0	273.1	343	308	381
18 x 8	450x200	457.0	219.1	343	298	381
20 x 18	500x450	508.0	457.0	381	368	508
20 x 16	500x400	508.0	406.4	381	356	508
20 x 14	500x350	508.0	355.6	381	356	508
20 x 12	500x300	508.0	323.9	381	346	508
20 x 10	500x250	508.0	273.1	381	333	508
20 x 8	500x200	508.0	219.1	381	324	508
22 x 20	550x500	559.0	508.0	419	406	508
22 x 18	550x450	559.0	457.0	419	394	508
22 x 16	550x400	559.0	406.4	419	381	508
22 x 14	550x350	559.0	355.6	419	381	508
22 x 12	550x300	559.0	323.9	419	371	508
24 x 10	550x250	559.0	273.1	419	359	508
24 x 22	600x550	610.0	559.0	432	432	508
24 x 20	600x500	610.0	508.0	432	432	508
24 x 18	600x450	610.0	457.0	432	419	508
24 x 16	600x400	610.0	406.4	432	406	508
24 x 14	600x350	610.0	355.6	432	406	508
24 x 12	600x300	610.0	323.9	432	397	508
24 x 10	600x250	610.0	273.1	432	384	508

DIMENSIONAL TOLERANCES AS PER ANSI B 16.9 / B 16.28 / MSS SP -43 BUTT WELD FITTING

ALL FITTINGS				90°/60°/45° /30° ELBOWS & TEES		REDUCERS		180° RETURNS				CAPS		ANGULARITY TOLERANCE ± 1/6" (1.6mm)							
Nominal Pipe Size Inch/mm	Outside Diameter at Level	Inside Dia meter	Wall Thickness at End	Centre to End		Overall Length Dimensions		Centre to End		Back to Face Dimensions		Alignment of End Dimensions		Overall length		Nominal Pipe Size	Off Angle Inch/mm	Off Plane			
	D		T		A,B,C,M		H		O		K		U		E		Q			P	
	(1) B16.9	MSS SP43	(2) B16.9	B16.9	MSS SP43	B16.9	MSS SP43	B16.9	MSS SP43	B16.9	MSS SP43	B16.9	MSS SP43	B16.9	MSS SP43	B16.9	MSS SP43	B16.9	MSS SP43	B16.9	
1/2" TO 2 1/2" 15 TO 65	±1.0		±0.8			FROM 1/2"TO10" 15TO250	FROM 3/4"	FROM 1/2"TO10" 15TO250	FROM 1/2"TO8"							±4	±3.17	1/2" TO 4" 15 TO 100	1		1
3" TO 3 1/2" 80 TO 90		±0.79																5" TO 8" 125 TO 200	2		4
4" 100	+2 -1		±1.6			±2	±1.59	±2	±1.59	±7	±6.35	±7	±6.35	±1.0	±0.79			10" TO 12" 250 TO 300	3		5
5" TO 6" 125 TO 150	+3 -1	+1.59														±7	±6.35	14" TO 16" 350 TO 400	3	16" TO 24" 400 TO 600	7
8" 200	±2	-0.79		Not Less Than Nominal Thk.	Not Less Than Nominal Thk.													18" TO 24" 450 TO 600	4	26" TO 36" 650 TO 900	10
10" TO 18" 250 TO 450	+4 -3	+2.38 -0.79	±3.2			FROM 12"TO30" ±3	±2.38	FROM 12"TO30" ±3	10"TO24" +2.38									26" TO 30" 650 TO 750	5	26" TO 36" 650 TO 900	10
20" TO 24" 500 TO 600	+6 -5	3.17 0.79				300TO750		300TO 750	250TO 600	±10"	±9.53			±2.0"	±1.59			32" TO 42" 800 TO 1050	5	26" TO 36" 650 TO 900	13
26" TO 30" 650 TO 750	+7 -5		±4.8															44" TO 48" 1100 TO 1200	5	38" TO 48"	20
32" TO 48" 800 TO 1200	+7 -5					±5												42" TO 48" 1050 TO 1200	±5	950 TO 1200 3.2	±20

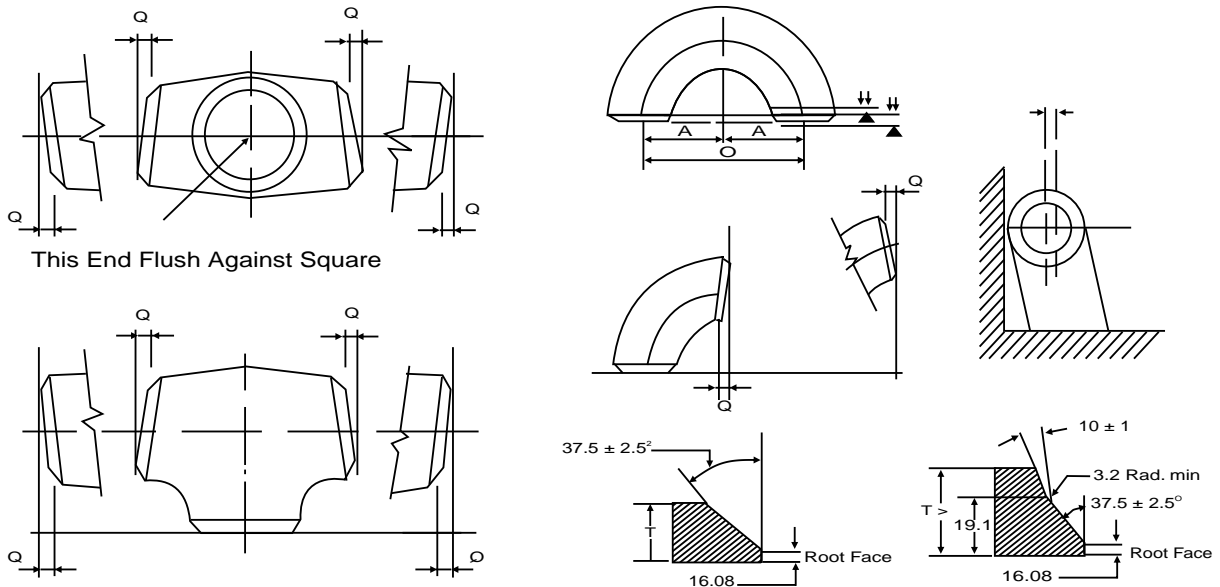

1. Out of round is the sum of absolute values of plus and minus tolerance.
2. The inside diameter at ends and the nominal wall thickness are to be specified by the purchaser.
3. Out of roundness tolerances shall be the difference between the Max. dia measured on any radial cross-section.
4. All dimensions are in millimeters except nominal pipe sizes which are in inches.

WELDING BEVEL STANDARDS ANSI B 16.25